

**DXF1.20(S) Series**  
Proportional Spring Return Actuators

**Application**

The **JOVENTA SPRING RETURN** electric damper-actuator series has been specially developed for the motorized operation of safety air dampers (anti-icing) in air conditioning systems, smoke evacuation dampers and sealing dampers. When the control signal is applied the actuator drives the damper to the operational position, while evenly tensioning the integrated spring. After a power failure the stored energy in the spring immediately brings the damper to the safety position. Manual operation is automatically cancelled when the actuator is in electrical operation. The compact design and universal adapter fitted with limitation of rotation angle make this actuator highly versatile.

**Features**

- 0(2)..10 V or 0(4)..mA control signal
- Up to 5 actuators in parallel operation possible
- Electrical connection with halogen-free cable
- Simple direct mounting with universal adapter on Ø 12 mm to 19 mm shaft or 10-12-14 mm square shaft.  
An optional M9220-600 Jackshaft Coupler Kit is available for 19 to 27 mm round shafts, or 16, 18, and 19 mm square shafts
- 80 mm min shaft length
- Tandem Operation possible
- Limitation of rotation angle
- Manual positioning with crank handle
- 2 auxiliary switches, 1 adjustable (See back page for settings)
- Automatic shut-off at end position (overload switch)
- Energy saving at end positions
- Actuators available with 1 m halogen-free cable
- Devices meet CE requirements



**Technical Specifications**

Actuator	DMF1.20(S)	DHF1.20(S)
Torque	20 Nm	20 Nm
Damper area*	4.0 m <sup>2</sup>	4.0 m <sup>2</sup>
Running time Motor	150 s	
Running time Spring return	26 s	
Supply Voltage	AC/DC 24V	
Frequency	50-60 Hz	
Power Consumption		
- Running AC	15.5 VA	
- Running DC	6.7 W	
- At end position AC	7.7 VA	
- At end position DC	2.9 W	
Dimensioning	15.0 VA	
Weight	2.9 kg	
Control signal	DC 0(2)...10 V or 0(4)...20 mA	
Working area Y	Not adjustable	Adjustable
Position signal	DC 0(2)...10 V	
Angle of rotation		
- Working range	90°	
- Limitation	0°...30° and 90°...60°	
Auxiliary Switches	3(1.5) A, AC 230 V	
- S1 setting range	10° fix	
- S2 setting range	25°...90° adjustable	
Cable	1.2 m halogen-free	
- Motor	4-wire 1-2-3-4	
- Switches	6-wire 21-22-23-24-25-26	
Lifetime	60'000 Rotations	
Noise level	55 dB (A)	
Protection class	II	
Degree of protection	IP 54	
Mode of action	Type1	
Ambient conditions		
- Operating temperature	-40...+55 °C / IEC 721-3-3	
- Storage temperature	-65...+85 °C / IEC 721-3-2	
- Humidity	5...95% r.F. no condensed	
Service	Maintenance-free	
Standards	CE, UL, CSA	
- Mechanics	EN 60 529 / EN 60 730-2-14	
- Electronics	EN 60 730-2-14	
- EMC Emissions	EN 50 081-1:92 / IEC 61000-6-3:96	
- EMC Immunity	EN 50 082-2:95 / IEC 61000-6-2:99	

\*Caution: Please note damper manufacturer's information concerning the open/close torque.

**DxF1.20(S) Series**  
Proportional Spring Return Actuators

**Signal adjust Position**

- Choose working field and position of position signal Y by rotary switch d1
- Processing sequence 1  
Increasing the signal position from 0(2) to 10 V the damper opens.
- Method of functioning 1 «DW»
- Processing sequence 2  
Decreasing the position signal from 10 V...2(0) the damper opens.
- Method of functioning 2 «UW»
- Y-position signal  
Voltage: 0(2)...10 VDC or  
Current: 0(4)...20 mA  
Attention: The 500Ω resistance is mounted Outside of the tool.  
(See the connection scheme)
- Factory-adjustment  
The tools are adjusted by factory to 0...10 V and Method of functioning «DW».
- Calibration  
If you set a rotation angle limit (e.g. 75°).  
The position signal Y can be adapted to the rotation angle by using the switch d1 on CAL position.
- CAL adjustement  
d1 on position 0...10 =  
Y-Input 0...10V for 90°  
d1 on position CAL =  
 $10V:90° = 0.11V \times 75° = 8.33V$   
d1 on position 2...10 =  
Y-Input 2...10V for 90°  
d1 on position CAL =  
 $8V:90° = 0.08V \times 75° = 6.66V$

**Control signal adjustment (Y)**

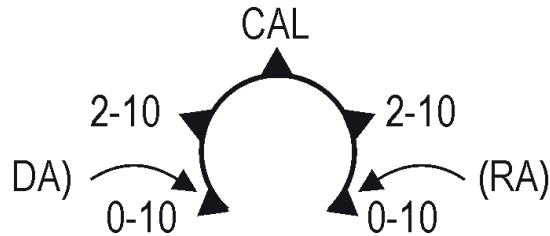

**Direct acting (CW)**

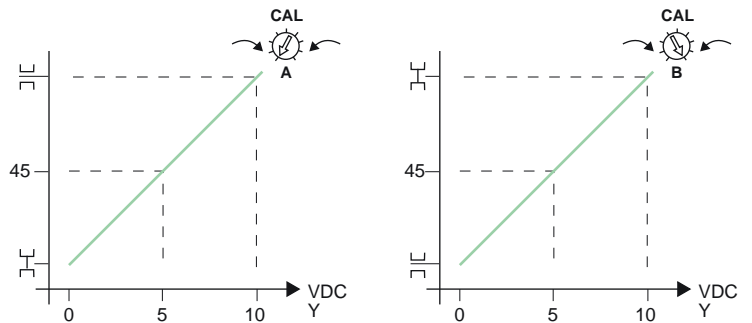

**Reverse acting (CCW)**

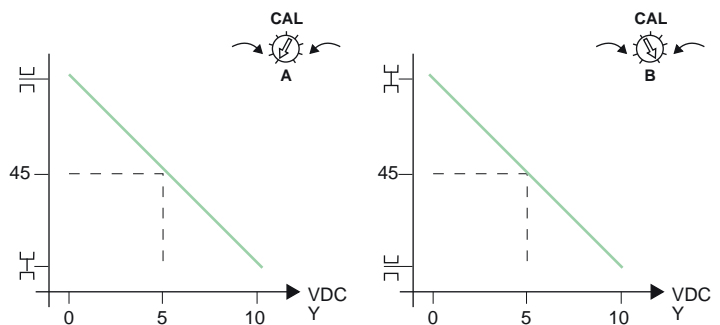

**CAL-adjustment**

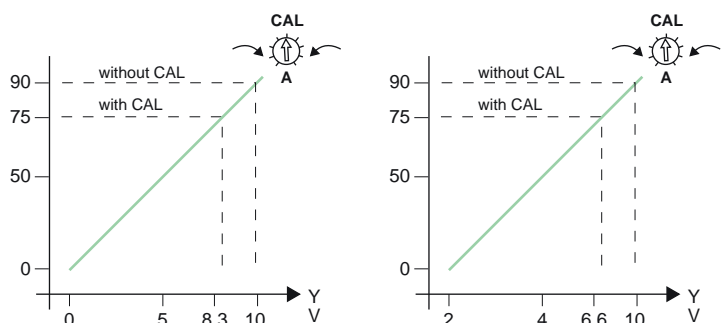

**DxF1.20(S) Series**  
Proportional Spring Return Actuators

**Wiring Diagrams**

DC 0(2)...10V Control

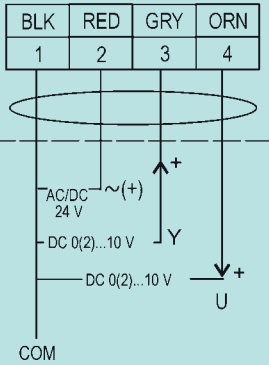

0(4)...20mA Control with External Resistor

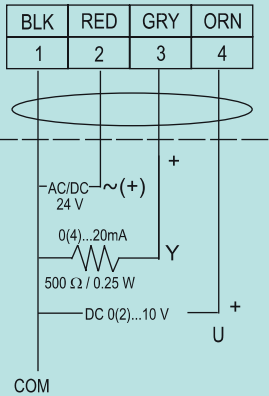

**Auxiliary Switches (S)**

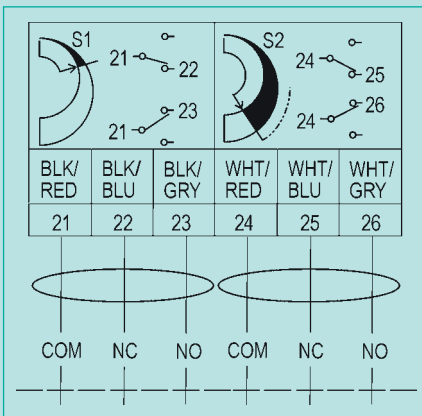

**Dimensions in mm**

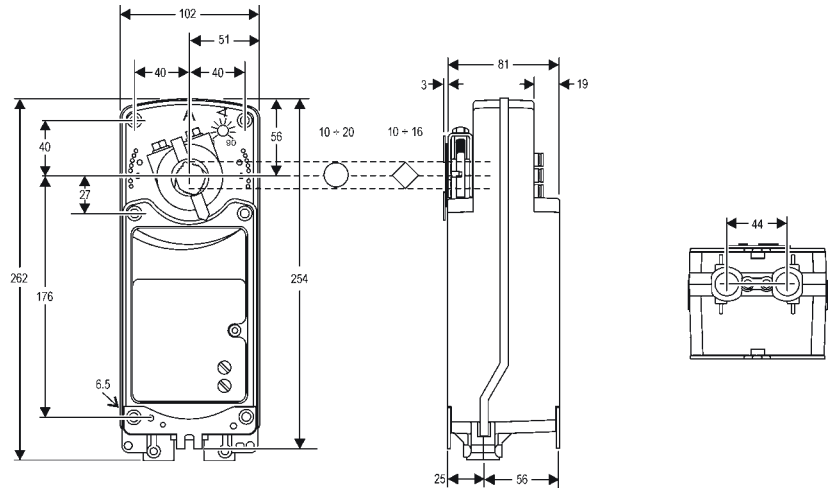

**Setting the auxiliary switches**

The 10S and 20S models include two integral auxiliary switches with a switch adjuster accessible on either face of the actuator. The nominal factory setting for auxiliary switch S1 is 11° closing, and the nominal factory setting for auxiliary switch S2 is 81° opening. The switch point of auxiliary switch S1 is fixed. The switch point of auxiliary switch S2 is independently and continuously adjustable from 25° to 95°. The switching position can be manually changed to any required position by turning the ratchet.

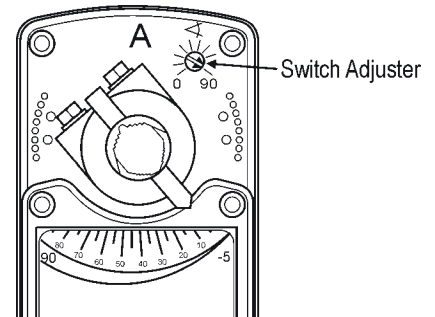

**Limitation of rotation angle**

Determine the desired rotation range. If a 65° to 90° rotation range is desired, add one stroke limiting stop. If a 35° to 60° rotation range is desired, add two stroke limiting stops. Mount the stroke stop(s) in the desired position using the two M4 x10 mm selftapping screws provided. Tighten the screws to a torque of 4 Nm. Manually reposition the coupler so that the coupler set screw aligns with the nodule guide that corresponds to the value determined in Step 2. For a rotation range of 65°, mount one stroke limiting stops in the minimum stroke position.

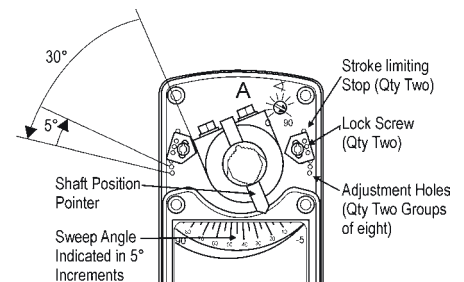

**DxF1.20(S) Series**  
Proportional Spring Return Actuators

**Ordering Codes**

Codes	Descriptions
DMF1.20	20 Nm, AC/DC 24 V
DMF1.20S	20 Nm, AC/DC 24 V, with 2 auxiliary switches
DHF1.20	20 Nm, AC/DC 24 V, adjustable span and offset
DHF1.20S	20 Nm, AC/DC 24 V, with 2 auxiliary switches, adjustable span and offset

**Accessories and Replacement Parts**  
(Order Separately)

Codes	Descriptions
M9000-158	Tandem Mounting Kit used to Mount Two Like Models of Dx F Series On/Off Electric Springback Actuators in Tandem to Deliver Twice the Torque
M9000-200	Commissioning Tool that Provides a Control Signal to Drive 24 V On/Off, Floating, Proportional, and/or Resistive Electric Actuators
M9000-604	Replacement Anti-Rotation Bracket Kit (with Screws) for Dx F Series On/Off Electric Springback Actuators
M9220-600	25 mm Jackshaft Coupler Kit (with Locking Clip) for Mounting Dx F Series On/Off Electric Springback Actuators on Dampers with 19 to 27 mm Round Shafts, or 16, 18, and 19 mm Square Shafts
M9220-601	Replacement Coupler Kit (with Locking Clip) for Mounting Dx F Series On/Off Electric Springback Actuators on Dampers with 12 to 19 mm Round Shafts or 10, 12, and 14 mm Square Shafts
M9220-602	Replacement Locking Clips for Dx F Series On/Off Electric Springback Actuators (Five per Bag)
M9220-603	Adjustable Stop Kit for Dx F Series On/Off Electric Springback Actuators
M9220-604	Replacement Manual Override Cranks for Dx F Series On/Off Electric Springback Actuators (Five per Bag)
M9220-610	Replacement Shaft Gripper, 10 mm Square Shaft with Locking Clip
M9220-612	Replacement Shaft Gripper, 12 mm Square Shaft with Locking Clip
M9220-614	Replacement Shaft Gripper, 14 mm Square Shaft with Locking Clip