

DA1.F(S) / DA2.F(S)
ON/OFF Spring Return Actuator

Application

The **JOVENTA** electric, Spring Return damper-actuator series has been specially developed for the motorized operation of safety air dampers (anti-icing) in air conditioning systems, smoke evacuation dampers and sealing dampers.

When the control signal is applied, the actuator drives the damper to the operational position, while evenly tensioning the integrated spring. After a power failure the stored energy in the spring immediately brings the damper to the safety position.

Manual operation is automatically cancelled when the actuator is in electrical operation.

The compact design and universal adapter fitted with limitation of rotation angle make this actuator highly versatile.

Features

- ON/OFF control
- Up to 5 actuators in parallel operation possible
- Plug-in terminal block connection
- Simple direct mounting with universal adapter on Ø 10 mm to 20 mm shaft or 10 mm to 16 mm square shaft 77 mm min shaft length
- Selectable direction of rotation
- Limitation of rotation angle
- Manual positioning with crank handle
- 2 adjustable auxiliary switches
(See back page for settings)
- Automatic shut-off at end position (overload switch)
- Energy saving at end positions
- Actuators available with 1m halogen-free cable

Accessories

- ZK Damper linkage selection
- ZKG Ball joints
(See data sheet 6.10)



Ordering Codes

Codes	Descriptions
DA1.F	AC/DC 24 V
DA1.FS	AC/DC 24 V, with 2 auxiliary switches
DA2.F	AC 230 V
DA2.FS	AC 230 V, with 2 auxiliary switches

DA1.F(S) / DA2.F(S)
ON/OFF Spring Return Actuator

Wiring Diagram

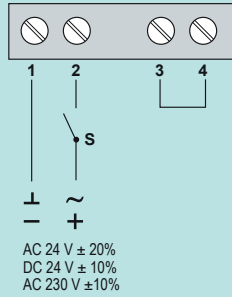

Parallel Connections

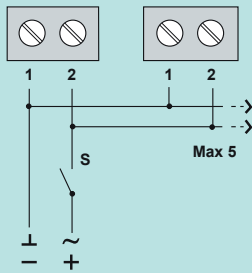

Auxiliary Switches (S)

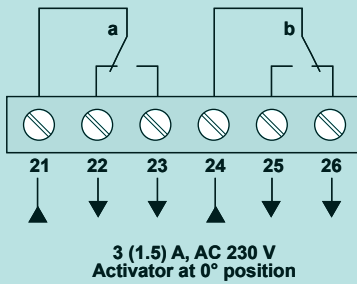

Dimensions in mm

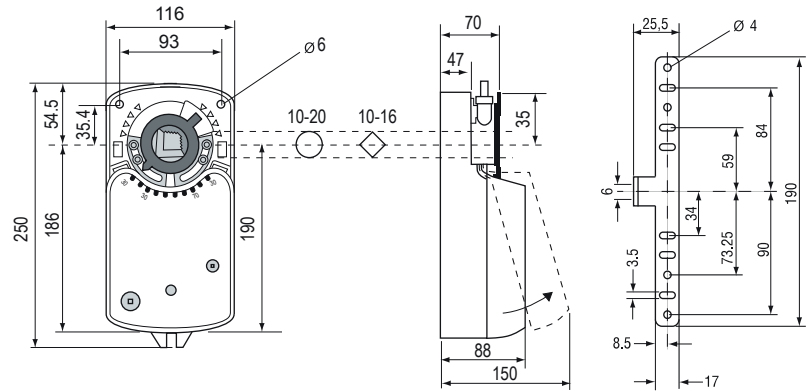

Changing the direction of rotation

The change in rotation direction is achieved by removing the adapter bush and replacing it on the other side.

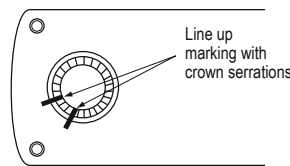

Factory setting:
Clockwise rotation.

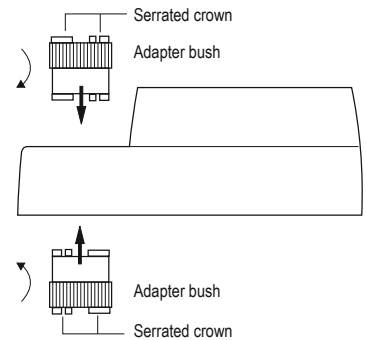

Setting the auxiliary switches

Factory setting
Switch **a** at 10°
Switch **b** at 80°

The switching position can be manually changed to any required position by turning the ratchet

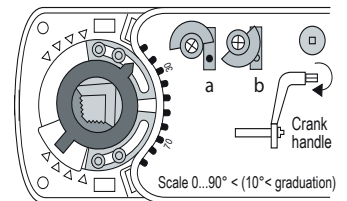

Limitation of rotation Angle

The limitation of rotation/working range can, through segments 1 and 2, be reduced by up to 30° from both end positions.

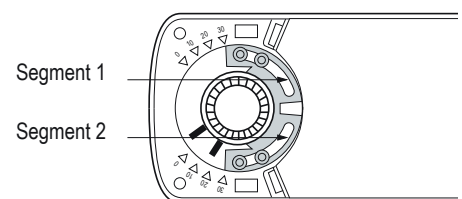

DA1.F(S) / DA2.F(S)
ON/OFF Spring Return Actuator

Technical Specifications

Actuator	DA1.F(S)	DA2.F(S)
Torque	16 Nm	
Damper area*	3.0 m ²	
Running Time Motor	90...120 s	
Running Time Spring Return	10 s	
Supply Voltage	AC/DC 24 V	AC 230 V
Frequency	50-60 Hz	
Power Consumption		
- Running	10.0 W	8.0 W
- At end position	4.0 W	4.5 W
Dimensioning	18.0 VA / 4 A @ 2 ms	13.0 VA / 0.3 A @ 2 ms
Control Signal	2-Point ON/OFF	
Position Signal	None	
Angle of rotation/Working range	90° (93°mech.)	
Angle of rotation/Limitation	0°...30° and 90...60°	
Auxiliary Switches	3(1.5) A, AC 230 V	
- Setting range	5°...85° < adjustable	
Cable aperture connection	PG11	
Life time	60.000 rotations	
Noise level	50 dB (A)	
Protection Class	II	
Degree of Protection	IP 54	
Mode of Action	Type 1	
Ambient conditions		
- Operating temperature	-20...+50 °C / IEC 721-3-3	
- Storage temperature	-30...+60°C / IEC 721-3-2	
- Humidity	5...95% r.F. no condensed	
Weight	2.7 Kg	
Service	Maintenance-free	
 Compliance	Johnson Controls, Inc., declares that these products are in compliance with the essential requirements and other relevant provisions of the EMC Directive 2004/108/EC and Low Voltage Directive 2006/95/EC	

*Caution: Please note damper manufacturer's information concerning the open/close torque.

Building Efficiency

Headquarters: Milwaukee, Wisconsin, USA
Branch Offices: Principal Cities World-wide

Johnson Controls® and Joventa® are registered trademarks of Johnson Controls, Inc.

All other marks herein are the marks of their respective owners.

© Copyright 2011 Johnson Controls, Inc. All rights reserved. Any unauthorized use or copying is strictly prohibited.