

BVA5.1: Rotary actuator with universal technology for ball valves

How energy efficiency is improved

Automatic adaptation to ball valve, precision control and high energy efficiency with minimal operating noise.

Features

- Stepping motor with UT (Universal Technology) electronic control unit
- Automatic detection of control signal applied (continuous or switching)
- The type of characteristic curve (linear, quadratic or equal percentage) can be adjusted in the drive
- Direction of travel can be switched on cable
- Electronic, load-dependent cut-off by means of stops in drive
- Coding switch for selection of characteristic and running time (35, 60 or 120 sec.)
- Maintenance-free gearbox with magnetic clutch
- Gearbox that can be disengaged for positioning the ball valve manually (with hand lever)
- Assembly with ball valve without any tools



Technical description

- Two-part housing made of self-extinguishing plastic, lower section black, upper section yellow
- Console and bayonet ring made of glass-fibre-reinforced plastic for fitting onto ball valve
- Connecting cable 1.2 m long, 5x 0.5 mm²
- Installation position: vertically to horizontally, but not upside down

Type	Running time s	Rotation angle	Voltage	Weight kg
BVA5.1	35 / 60 / 120	90°	24 V AC/DC	0,7
Positioner ¹⁾				
Control signal	0...10 V, R _i > 100 kΩ	Start point U ₀	0 or 10 V	
Position feedback signal	0...10 V, load > 10 kΩ	Control span ΔU	10 V	
		Switching range X _{sh}	200 mV	
Supply voltage	24V~ ± 20%, 50...60 Hz 24V= ²⁾ + 20% / - 10%	Protection class (horiz.)	IP54acc. to EN 60529	
		Protection class	III acc. to IEC 60730	
Power consumption	4,9 W 8,7 VA	Response time ¹⁾	200 ms	
Max. medium temperature ³⁾	100 °C	Connection diagram	A10520	
Perm. ambient temperature	-10...55 °C	Dimension drawing	M10489	
Perm. ambient humidity:	5...95% rh without condensation	Fitting instructions	P100001578	
		Declaration on materials and the environment	MD 51.364	
Zubehör				
S1.VA250	1x auxiliary switch			
S2.VA250	2x auxiliary switches			

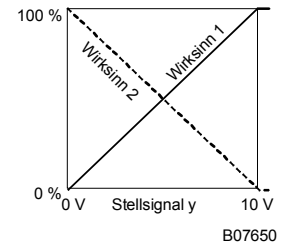

Function

Depending on the type of connection (see connecting plan) the actuator can be used as a continuous 0...10 V actuator or a 2-point (open/closed) or 3-point (open/stop/closed) actuator with intermediate position.

The running time of the actuator can be set in accordance with requirements using coding switches. The equal-percentage, linear or quadratic characteristic curve can be selected using the coding switches. The BVA10.1 is combined with ball valves with an equal percentage basic characteristic curve like the VKR or BKR.

Manual adjustment takes place by disengaging the gearbox (slide switch next to connecting cable) and simultaneous rotation using the manual adjusting lever. The actuator position is indicated by the manual adjusting lever or the indicator knob on the upper part of the actuator.

Attention: return slide switch after making manual adjustment (engage gearbox).

Connection as 2-point valve actuator

This open/closed actuation can take place via 2 cables. The actuator is connected to the voltage via the blue and brown cables. The control branch of the ball valve is opened by applying voltage to the black cable. When this voltage is switched off, the actuator moves to the opposite end position and closes the ball valve.

The unused red and grey lines must not be connected or come into contact with other cables. We recommend that these cables be isolated.

Connection as 3-point actuator

The ball valve can be moved to any position by applying voltage to the brown or black cable. Direction of rotation (viewed from drive to ball valve spindle):

- - axle rotates clockwise with voltage applied to brown cable, closes the ball valve.
- - axle rotates anticlockwise with voltage applied to black cable.

In the end positions (stop in drive, maximum rotation angle of 95 ° reached) or in the event of overloading the electric motor shut-off mechanism is activated (not a limit switch). The rotating angle can be changed by swapping the cables.

The unused red and grey lines must not be connected or come into contact with other cables. We recommend that these cables be isolated.

Connection for 0...10 V control voltage

The built-in positioner controls the actuator depending on the controller output signal y.

Direction of rotation (viewed from drive to ball valve spindle):

Mode of action 1 (mains voltage applied to brown cable):

As the output signal increases, the driver axle rotates anticlockwise and opens the control passage of the ball valve.

Mode of action 2 (mains voltage applied to black cable):

As the output signal increases, the driver axle rotates clockwise and closes the control passage of the ball valve.

The start point and the control span are fixed.

Voltage must only be applied to either the brown cable or the black cable. The cable that is not used must be isolated (if not connected to a switch).

Since the start point and the control span are fixed, a split range unit is needed to adjust partial ranges (accessory).









After manual adjustments or if the voltage has been interrupted for more than 5 minutes the actuator recalibrates itself, with a running time of 60 s in all cases.

When the supply voltage is applied the stepping motor moves to the 100% position, makes the connection to the driver axle, moves to the 0% position and therefore defines the operating range. It is then possible to move to any position between a rotation angle of 0 und 90 °, depending on the control voltage. Thanks to the electronics no steps are lost, and the actuator does not require occasional recalibration. The parallel running of several drives of this type is guaranteed. The positional feedback $y_0 = 0...10$ V corresponds to the effective rotation angle of 0 to 90 °.

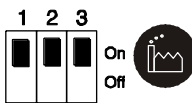
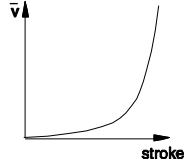
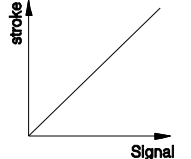
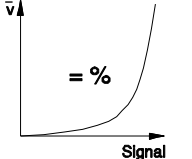
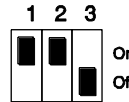
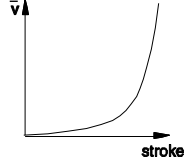
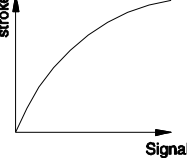
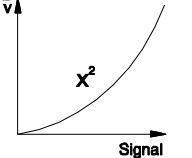
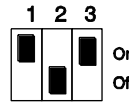
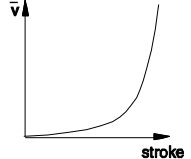
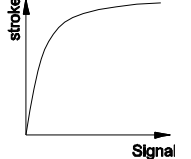
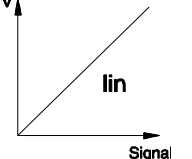
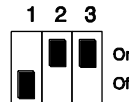
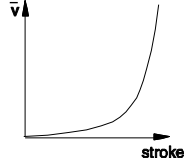
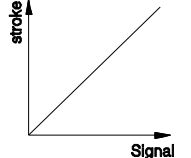
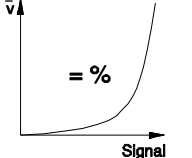
If the 0...10 V control signal is interrupted and mode of action 1 is connected, the ball valve is fully closed (0% position).

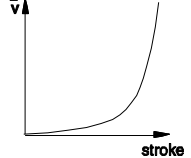
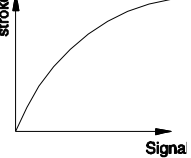
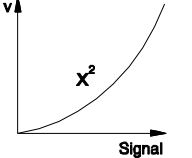
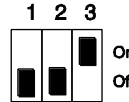
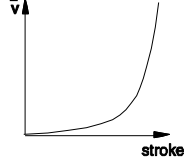
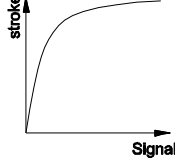
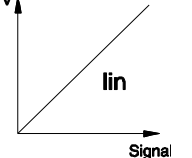
The characteristic curve of the ball valve can be selected using the coding switch. Characteristic curves can only be generated if the drive is used as a continuous drive. The running times can be selected using other switches. These can be used regardless of whether the 2-point, 3-point or continuous function has been selected.

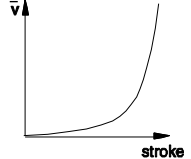
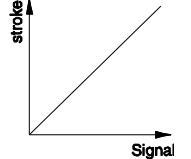
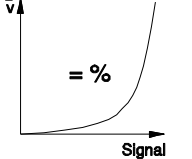
Coding switches for running time and characteristic curve selection

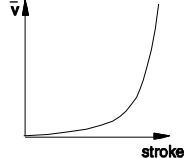
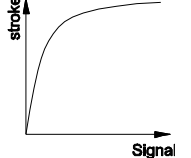
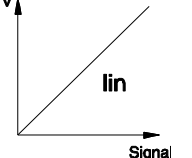
Position of switches				Running time/angle s/90°
				120 s ± 4
				120 s ± 4
				120 s ± 4
				60 s ± 2
				60 s ± 2
				60 s ± 2
				35 s ± 1
				35 s ± 1

Engineering and fitting notes

Condensation, drip water etc. must be prevented from penetrating the drive along the carrier axle.

When the electrical connection is being made, it must be ensured that the cross-section of the supply line is adapted to the output and the length. However, we recommend a minimum cross-section of 0,75 mm².

The drive / ball valve are installed by fitting them and rotating the bayonet ring as far as it will go without any further adjustment. No tools are needed. The spindle of the ball valve is connected to the driver axle automatically, either by moving to a rotation angle of 100% using manual adjustment or by applying the voltage. Dismantling takes place by simply opening the bayonet ring and removing the drive. The delivery setting is the centre position.

The stepping motor and electronic system ensure that several valve drives of the same SUT type will run in parallel.

If a potentiometer is needed, the accessories of VA250/500 can be used but display (% rotation angle) on the name plate will be inverted. The maximum accessory configuration that can be used for an actuator is 1 auxiliary change-over switch or 1 potentiometer.

The auxiliary change-over switch accessory is screwed to the top cover of the actuator. The indicator knob must be removed to make the mechanical connection. A new indicator can be seen on the cover of the accessory.

The coding switches are accessible via a prepared opening with a black cover in the top of the housing.

Attention! The housing must not be opened.

Fitting outdoors. We recommend that the equipment is provided with additional protection from the weather if it is installed outside.

Additional technical tasks

The upper housing with cover, indicator knob and cover knob contains the stepping motor and the UT electronics. The lower part of the housing contains the maintenance-free gearbox.

Auxiliary change-over switch

Switching capacity max. 230 V~, current min. 20 mA at 20 V

Switching capacity max. 4...30 V=, current 1...100 mA

Power consumption:

Type	Running time s	Condition	active power P W	apparent power S VA
BVA5.1	35	Operation	2,45	4,75
		Stationary	0,35	0,8
	60	Operation	4,9	8,7
		Stationary	0,35	0,75
	120	Operation	2,25	4,3
		Stationary	0,35	0,75

CE conformity

EMC directive 2004/108/EC

EN 61000-6-1

EN 61000-6-3

EN 61000-6-4

Machinery directive 98/37/EEC (II B)

EN 1050

Connection diagram

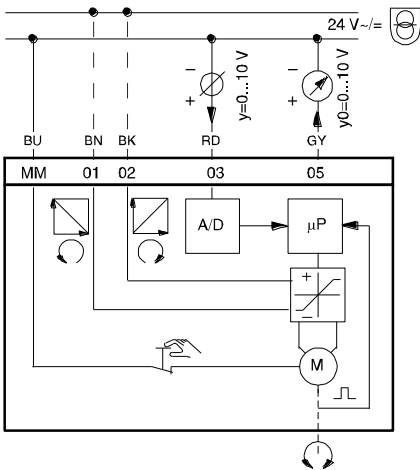

Variante 1 (3pt)

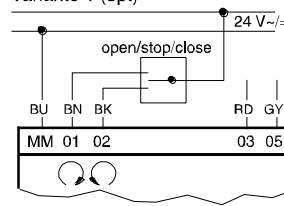

Variante 2 (2pt)

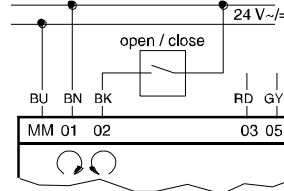

RD = red
 BN = brown
 BK = black
 BU = blue
 GY = grey

A10520a

Dimension drawing

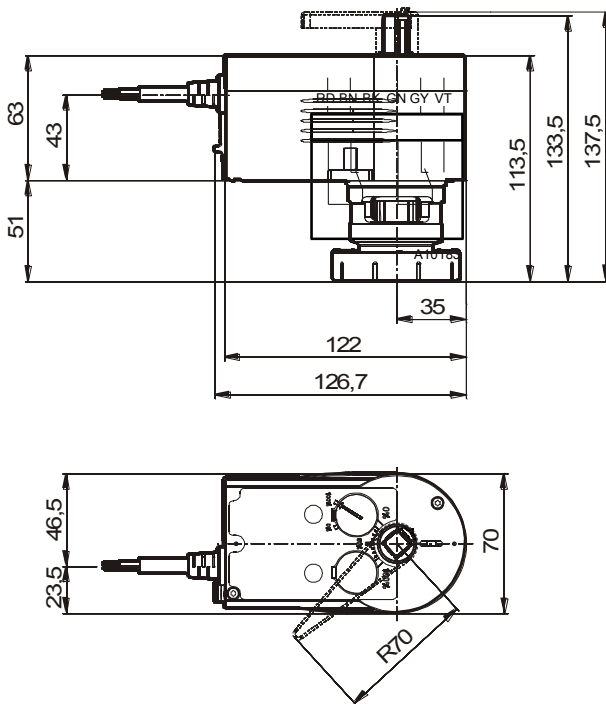

M10489

Accessories

S1.VA250

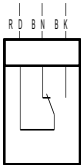

A 09782

RD = red
 BN = brown
 BK = black
 GN = green
 GY = grey
 VT = violet

S2.VA250

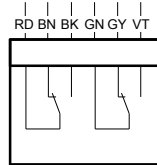

A10183