

Smart controller M240 with high resolution touch screen to control and monitor up to 240 motorized fire or smoke extraction dampers and 120 smoke detectors via BACnet or Modbus.



Content

Section (continuation)	Page	Section (continuation)	Page
Technical Data	1	Communication/Integration in Superior Systems (Modbus/BACnet)	8
Cable Specification	3	Communication Layout	9
Functionalities / Dimensions	5	Remote Access through Cloud (available free of charge)	10
Electrical Installation	6	Bus Monitoring Functionality	10
Explanation Application	7	User Manual	10
Functionality Dip Switches	8		

Technical Data

Electrical Data	Operating Voltage	5 V DC (Power supply for 230 V AC included in delivery)
	Power Consumption	< 10 W
	Electric Current	3 A
	Connections	Quick connection terminals

Communication / Modbus Functionality



For 2 zones with max. 60 FSC-UFC24, FSC-UFC24-2, FSC-UFC230-2, FSC-UFC24-NM-4, FSC-UFC24-230 per zone. For easy integration into any superior Modbus system. Takes over the controls function for the participants of the 2 zones

Protocol	Modbus RTU
Medium	RS-485, not electrically isolated
Transmission Formats	Specified by Modbus RTU standards
Baud Rate	9.600 bps
Modbus Dedicated Port	Connect any Modbus system to the dedicated port of the FSC-M240 to monitor or access the parameters in the connected FSC-UFC24, FSC-UFC24-2, FSC-UFC230-2, FSC-UFC24-NM-4, FSC-UFC24-230.

	Addresses	Modbus addresses 121 (zone 1) and 122 (zone 2) for the FSC-M240
	Termination	120Ω line termination. Jumper available on extra pin on PCB for each zone. Position of jumper if FSC-M240 is last Modbus device in line, see page 6
	Typical Response Time	< 500 ms
Communication / BACnet	Functionality	For 2 zones with max. 60 BACnet devices per zone (FSC-UFC24, FSC-UFC24-2, FSC-UFC230-2, FSC-UFC24-NM-4, FSC-UFC24-230). For easy integration into any superior BACnet system. Takes over the controls function for the participants of the 2 zones
	Protocol	BACnet MS/TP
	Medium	RS-485, not electrically isolated
	Number of Devices per Line	Max. 60 BACnet devices (FSC-UFC24, FSC-UFC24-2, FSC-UFC230-2, FSC-UFC24-NM-4, FSC-UFC24-230) without repeater. Two lines with max. 60 devices each available
	Baud Rates	Auto detect. 9.600, 19.200, 38.400, 76.800 bps. Default 38.400 bps
	Device Instant Addresses	Zone 1: 804121; Zone 2: 804122 FSC-UFC... addresses from 1-60 (zone 1) and 61-120 (zone 2)
	Termination	120Ω line termination. Jumper available on extra pin on PCB for each zone. Position of jumper if FSC-M240 is last BACnet device in line, see page 6
	Typical Response Time	< 100 ms
Safety	Protection Class	III
	Protection Degree	IP42, housing of non-flammable polycarbonate
	EMC Correlation Emission	EN61000-6-3 and EN55022
	EMC Correlation Immunity	EN50130-4 and EN55024
	Electrical Safety	EN60950-1
	Ambient Temperature	10° C to +30° C
	Storage Temperature	0° C to +40° C
	Maintenance	Maintenance free

Mechanical Data (Dimensions / Weight)	Width	136 mm
	Height	77 mm (with bracket 80 mm)
	Length	188 mm
	Weight	approx. 1 kg
	See drawing page 5.	

Installation Mounted on DIN Rail, mounting bracket or screw fixed.

Electrical Installation See details page 6.

Safety Notes The FSC-M240 is not allowed to be used outside the specified field of application, especially in aircraft or in any other airborne means of transport. The company buying and / or mounting the FSC-M240 on site bears full responsibility for the proper functioning of the whole system. Only authorized specialists may carry out the installation. All applicable legal or institutional installation regulations must be complied with during installation. The device contains electrical and electronic components and is not allowed to be disposed of as domestic refuse. All locally valid regulations and requirements must be observed.

Product Features / Application The FSC-M240 is a smart controller with a high resolution touch screen to control and monitor up to 240 motorized fire or smoke extraction dampers, 120 smoke detectors as well as 120 thermoelectric tripping devices. Two zones can be built with the FSC-M240: Either two fire or two smoke extraction zones or one fire and one smoke extraction zone. It is mounted in the cabinet or according to customer's need. Integrated real time clock and intuitive handling. Internet access via WiFi and W-Lan. Cloud access available.
Fully autonomous operation (Stand Alone Application) or Bus integration via BACnet or Modbus (RS-485) into a Building Automation System possible. Per zone: control of 1 ventilator (input/output), 1 alarm input (external alarm), 1 alarm output (internal alarm) and other inputs/ outputs are integrated.

Power Supply The FSC-M240 needs to be powered up with 5 V DC (Power supply for 230 V AC included in delivery).

Cable Specification



For the connection of the FSC-M240 with the FSC-UFC... devices the following cable specifications apply:
120Ω with 1 Mhz. Made of 24 # flexible twisted pairs overall foil + braidshielded and overall jacketed with a flexible compound for indoor use, or similar. Cable type: Belden 3105a or equivalent.

IMPORTANT: SMT takes no responsibility of the functionality of the units/network if a different cable is used to the one specified here.

Communication Modbus RTU (RS-485) or BACnet MS/TP (RS-485).
Remote control via WiFi or W-Lan connection possible.
Cloud access available.

Connection Field Devices Up to 120 pcs. (2 x 60) FSC-UFC24, FSC-UFC24-2, FSC-UFC230-2, FSC-UFC24-NM-4, FSC-UFC24-230 can be connected to the FSC-M240. The FSC-M240 automatically recognizes the connected FSC-UFC... (automatic recognition of the addresses, subject to correct addressing through the dip switches). The addressing of the FSC-UFC... is recommended to be done in consecutive order.

Additional Connections *Input and Output Modules*
I/O connections 6 x DO, 6 x DI
Input for Fire Alarm System is included in the 6 DI.

! IMPORTANT NOTICE Please be aware, that the FSC-M240 gives **NO** signal for the fans to be shut off when testing only single dampers. Depending on where the damper is located, a manual shut down of the fans has to be considered when testing a single damper (e.g. the one which is closest to the fan). This is in the responsibility of the person / company doing the tests. SMT AG will not take any liability in any such case.

! PROPER HANDLING The screen is connected to the body by 3 cables. Do not disassemble the cables. When the screen unit needs to be disconnected from the I/O unit, carefully take out the 3 plugs on the PC-board mounted in the body. **1**

IMPORTANT: Do not touch the electronics. Handle with care. Do not let the screen unit hanging loose only being supported by the 3 cables.

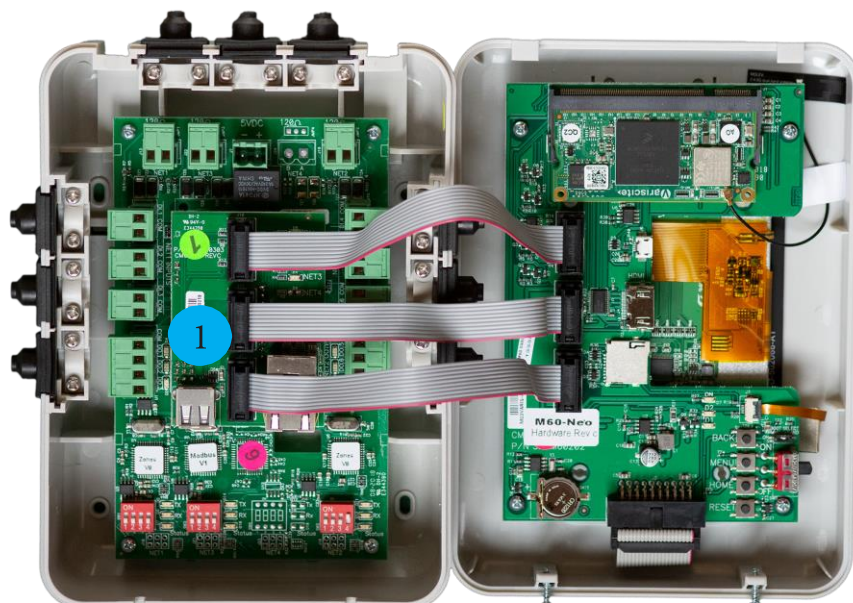

Functionalities / Dimensions

Functionalities

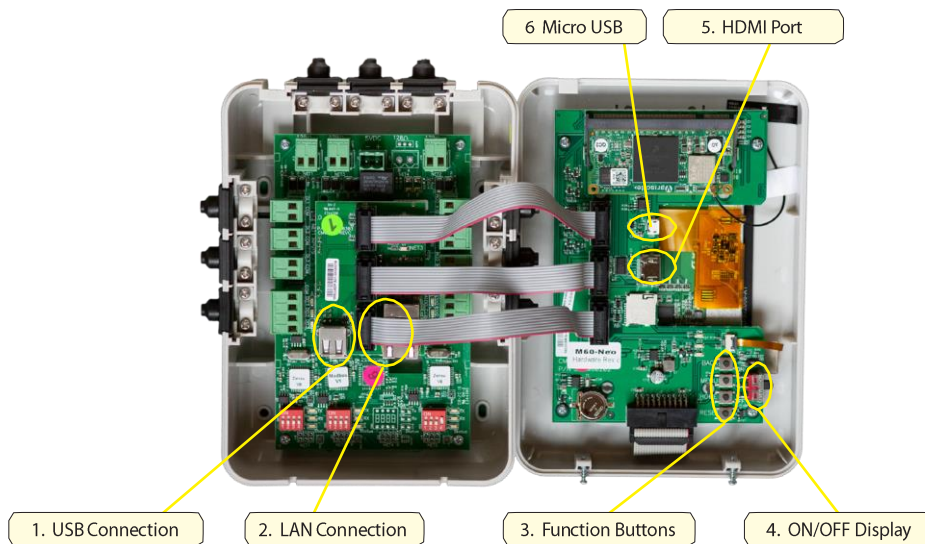

1.	USB Connection	USB Socket, for internal use only.
2.	LAN connection	Socket for a LAN cable to connect the controller to the internet.
3.	Function Buttons	For internal use only.
4.	ON/OFF Display	The switch needs to be in ON position.
5.	HDMI Port	HDMI Socket, not in use.
6.	Micro USB	Micro USB Socket, for internal use only.

Dimensions

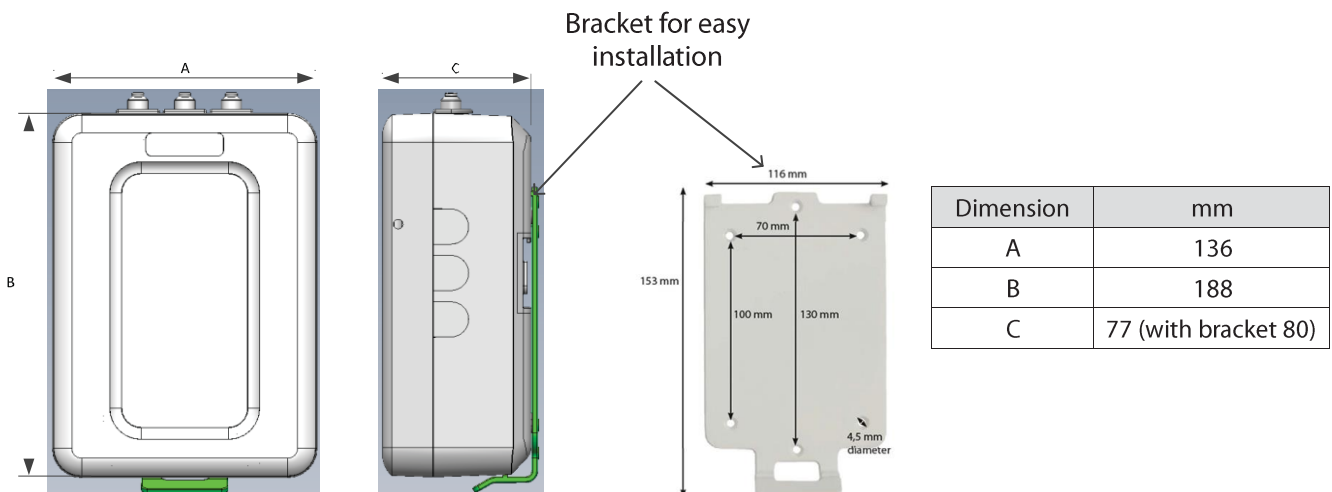

Electrical Installation

General Information

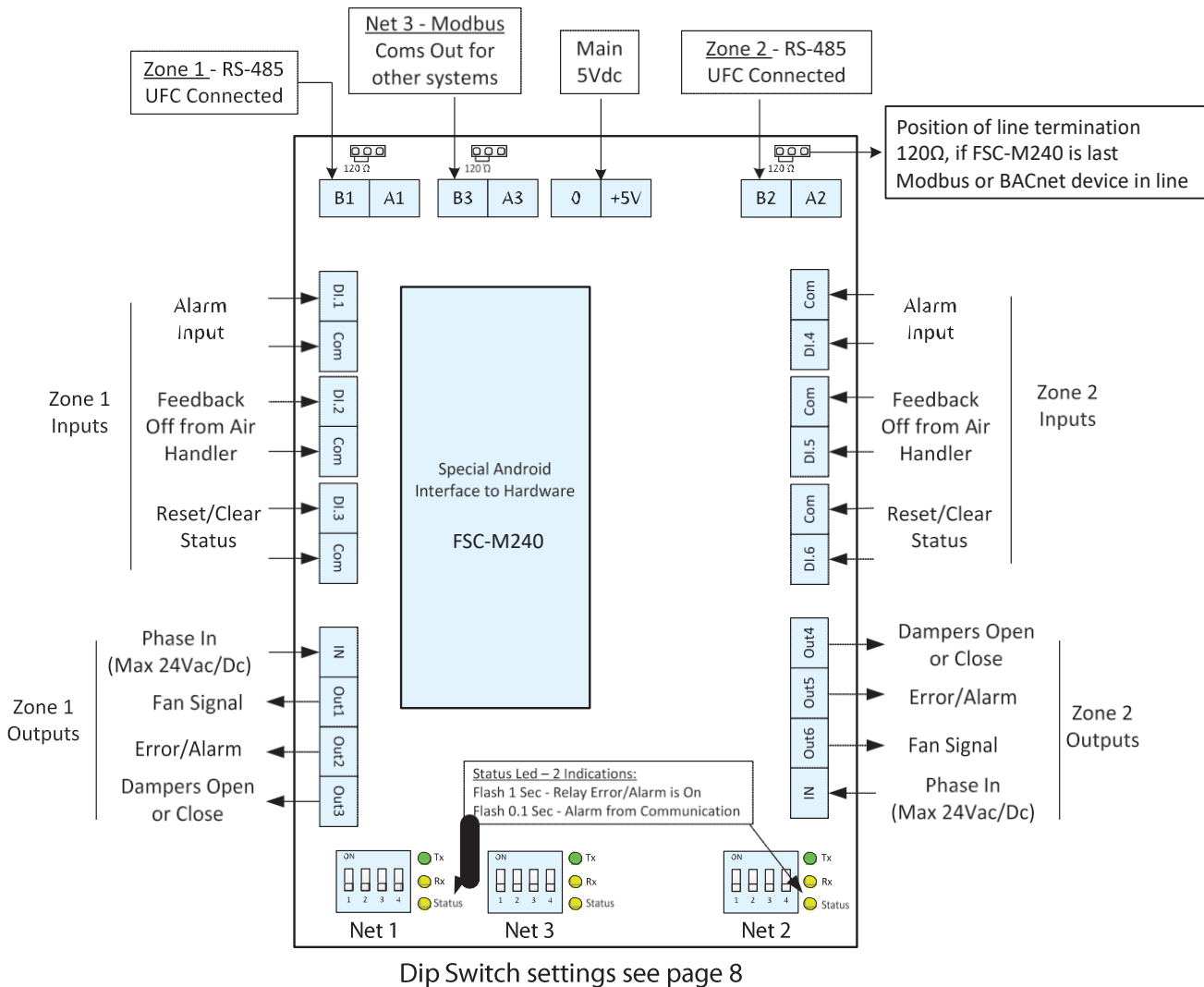

Modbus slave (Net 3):

The FSC-M240 can be used as slave for the integration into a Modbus network through Net 3. In this case the FSC-M240 operates at the same time as master of all connected devices in zones 1 and 2. Zone 1 has Modbus address 121 and zone 2 Modbus address 122 assigned.

Zone 1 – Inputs and outputs on FSC-M240 – device 121.

Zone 2 – Inputs and outputs on FSC-M240 – device 122.

IMPORTANT: The fire and smoke extraction application cannot be combined within one zone! This means that the two available zones can either be used as two fire safety or two smoke extraction zones or one fire safety and one smoke extraction zone. The control mode is set through the red dip switch terminal in the UFC devices.

Explanation Application

Fire Damper Application:

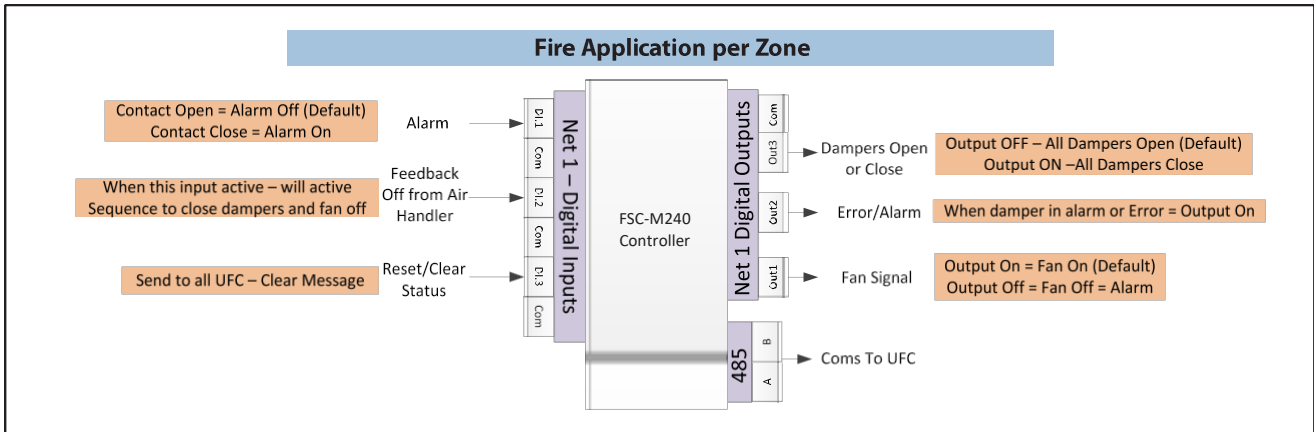

Smoke Extraction Application:

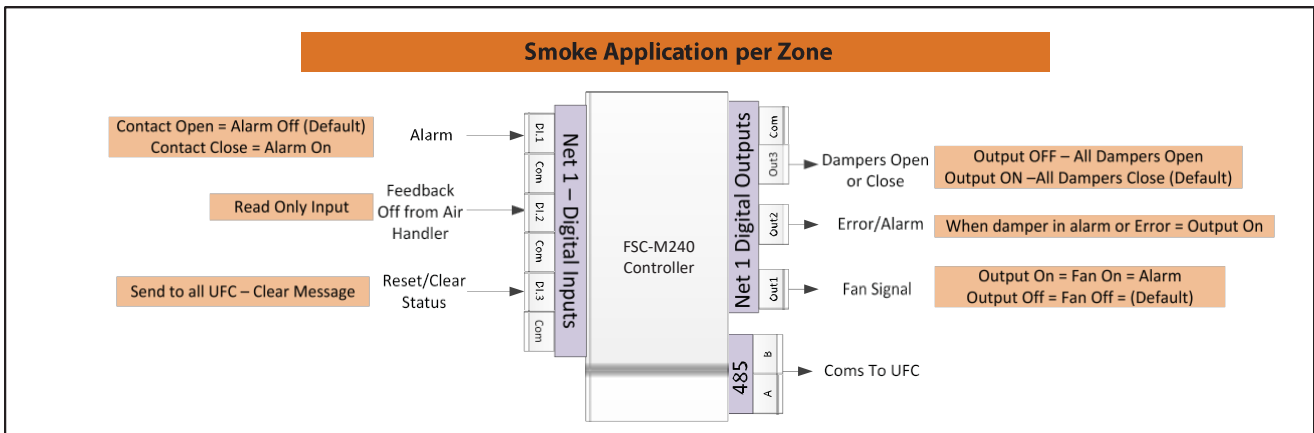

Functionality Dip Switches

Default setting Net 1 / Zone 1:

Default setting Net 2 / Zone 2:

For the correct operation of the FSC-M240, dip switch no 4 of zone 2 (net 2) needs ALWAYS to be on ON.

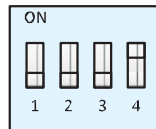
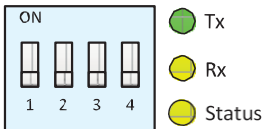

Pin	Off (Default)	On
1	Alarm in single FSC-UFC...**	Alarm all dampers in Zone 1 or 2*
2	Fire-Application	Smoke-Application
3	Auto Baudrate	Baudrate 9600
4	For Internal Use Only	
	Zone 1 = Off = Address 121	Zone 2 = On = Address 122

* Meaning: If pin 1 for zone 1 is ON and there is an alarm in this zone, all dampers will go to their safety position in zone 1. Same for zone 2 if pin 1 for zone 2 is ON.

** Meaning: If pin 1 for zone 1 is OFF and there is an alarm only the damper connected to the FSC-UFC... which detects an alarm will go to its safety position. All other dampers in this zone remain in the initial position. Same if pin 1 for zone 2 is OFF. The alarm signal will be visible on the FSC-M240.

Net 3

Modbus Port: Fixed baud rate 9'600 bps.

Communication/Integration in Superior Systems (Modbus/BACnet)

General information

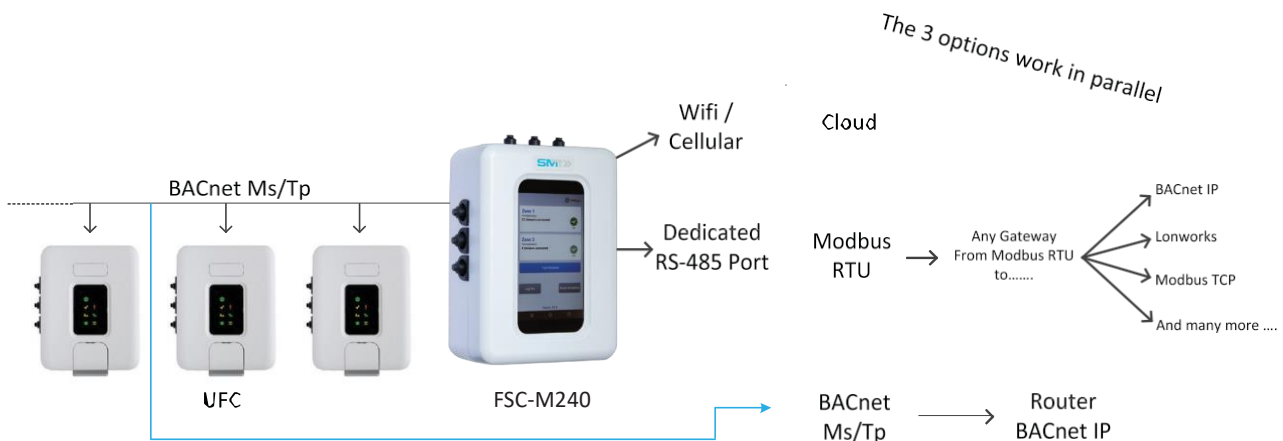

Communication Layout

BACnet MS/TP, Modbus RTU

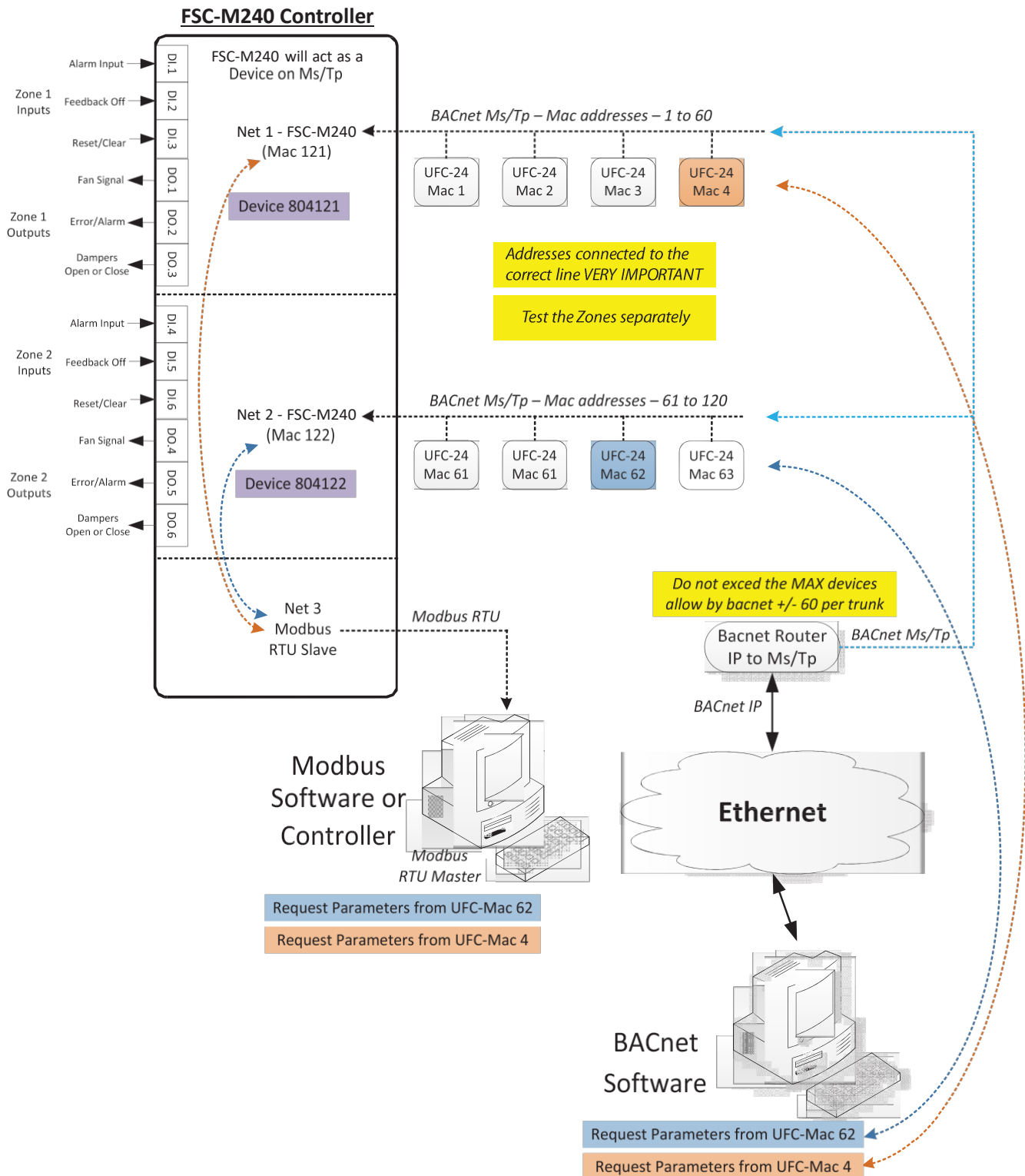

Remote Access through Cloud (available free of charge)

There is the possibility to access the FSC-M240 remotely via a Cloud.

Advantages of Cloud access:

- o Access to each project anytime possible without having to go there physically => complaints, service calls
- o Test reports and alarm messages (alerts) can be automatically sent to registered email addresses
- o For the testing of the dampers only one person is needed (confirmation during physical inspection via mobile phone => automatic logging)

Please contact us for more details.

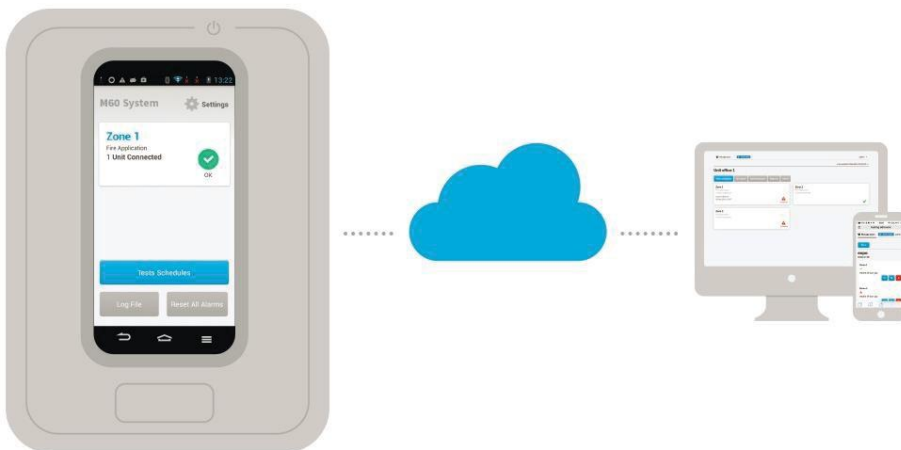

Bus Monitoring Functionality

There is the possibility to activate the bus monitoring function of the system directly in the FSC-M240. The functionality can be activated in a simple way for the whole zone or for an individual FSC-UFC... If the bus communication to a FSC-UFC..., in which the functionality is activated, is interrupted, the damper is moving to its safety position after the defined delay time.

User Manual

For more information regarding the configuration of the FSC-M240 or about the activation of the bus monitoring functionality etc. please refer to the user manual or to the data sheets of the specific FSC-UFC...

FRAKTA Vertriebs GmbH
Riedwiese 13/1
72229 Rohrdorf
Telefon: 074526051991
Mail: info@frakta.de